

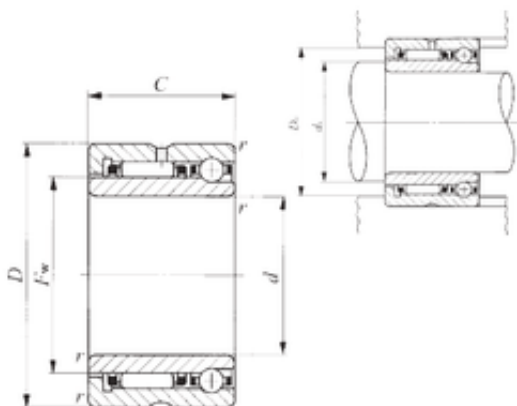

NSK bearing Trading Co., Ltd

25 mm x 42 mm x 23 mm 25 mm x 42 mm x 23 mm IKO NATA 5905 complex bearings



Bearing No. NATA 5905

Size	25x42x23 mm
Bore Diameter	25 mm
Outer Diameter	42 mm
Width	23 mm
d	25 mm
Fw	30 mm
D	42 mm
B	23 mm
C	23 mm
r min.	0,3 mm
da min.	27 mm
Da max.	40 mm
Weight	0,131 Kg
Dynamic load rating radial (C)	15,8 kN
Dynamic load rating axial (C)	4,3 kN
Static load rating radial (C0)	22,1 kN
Static load rating axial (C0)	7,52 kN

NATA 5905 Bearing 2D drawings and 3D CAD models